

## High temperature 25 A Snubberless™ TRIAC

### Features

- Medium current TRIAC
- 150 °C max. Tj turn-off commutation
- Low thermal resistance with clip bonding
- Very high 3 quadrant commutation capability
- RoHS (2002/95/EC) compliant package

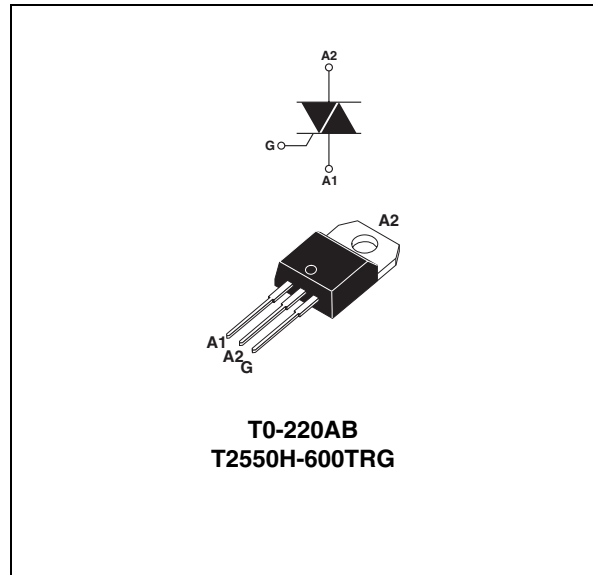
### Applications

Specifically designed for use in high temperature environment (found in hot appliances such as cookers, ovens, hobs, electric heaters, coffee machines).

### Description

This 25 A T2550H TRIAC provides an enhanced performance in terms of reduced power loss and thermal dissipation. This allows for the optimization of the heatsinking dimensions, leading to space and cost effectiveness when compared to electro-mechanical solutions.

Based on ST snubberless technology, the T2550H offers high commutation switching capabilities and high noise immunity levels. Thanks to the clip assembly technique, it provides a superior performance in surge current handling.



**Table 1. Device summary**

Symbol	Value	Unit
$I_{T(RMS)}$	25	A
$V_{DRM}/V_{RRM}$	600	V
$I_{GT(Q_1)}$	50	mA

# 1 Characteristics

**Table 2. Absolute maximum ratings**

Symbol	Parameter			Value	Unit
$I_{T(RMS)}$	RMS on-state current (full sine wave)		$T_c = 125\text{ °C}$	25	A
$I_{TSM}$	Non repetitive surge peak on-state current (full cycle, $T_j$ initial = 25° C)	F = 50 Hz	t = 20 ms	250	A
		F = 60 Hz	t = 16.7 ms	260	
$I^2t$	$I^2t$ Value for fusing		$t_p = 10\text{ ms}$	340	A <sup>2</sup> s
dI/dt	Critical rate of rise of on-state current $I_G = 2 \times I_{GT}$ , $t_r \leq 100\text{ ns}$	F = 120 Hz	$T_j = 150\text{ °C}$	50	A/ $\mu$ s
$V_{DSM}/V_{RSM}$	Non repetitive surge peak off-state voltage	$t_p = 10\text{ ms}$	$T_j = 25\text{ °C}$	700	V
$I_{GM}$	Peak gate current	$t_p = 20\text{ }\mu$ s	$T_j = 150\text{ °C}$	4	A
$P_{G(AV)}$	Average gate power dissipation		$T_j = 150\text{ °C}$	1	W
$T_{stg}$ $T_j$	Storage junction temperature range Operating junction temperature range			- 40 to + 150 - 40 to + 150	°C

**Table 3. Electrical characteristics ( $T_j = 25\text{ °C}$ , unless otherwise specified)**

Symbol	Test Conditions	Quadrant		Value	Unit
$I_{GT}^{(1)}$	$V_D = 12\text{ V}$ $R_L = 33\text{ }\Omega$	I - II - III	MAX.	50	mA
$V_{GT}$		I - II - III	MAX.	1.3	V
$V_{GD}$	$V_D = V_{DRM}$ $R_L = 3.3\text{ k}\Omega$ $T_j = 150\text{ °C}$	I - II - III	MIN.	0.15	V
$I_H^{(2)}$	$I_T = 500\text{ mA}$		MAX.	75	mA
$I_L$	$I_G = 1.2 I_{GT}$	I - II - III	MAX.	90	mA
dV/dt <sup>(2)</sup>	$V_D = 67\% V_{DRM}$ gate open $T_j = 150\text{ °C}$		MIN.	500	V/ $\mu$ s
(dI/dt) <sub>c</sub> <sup>(2)</sup>	Without snubber $T_j = 150\text{ °C}$		MIN.	11.1	A/ms

1. minimum  $I_{GT}$  is guaranteed at 10% of  $I_{GT}$  max.
2. for both polarities of A2 referenced to A1.

**Table 4. Static Characteristics**

Symbol	Test Conditions			Value	Unit	
$V_T^{(1)}$	$I_{TM} = 35\text{ A}$	$t_p = 380\text{ }\mu$ s	$T_j = 25\text{ °C}$	MAX.	1.5	V
$V_{to}^{(1)}$	Threshold voltage		$T_j = 150\text{ °C}$	MAX.	0.80	V
$R_d^{(1)}$	Dynamic resistance		$T_j = 150\text{ °C}$	MAX.	19	m $\Omega$
$I_{DRM}$ $I_{RRM}$	$V_{DRM} = V_{RRM}$	$T_j = 25\text{ °C}$	MAX.	5	$\mu$ A	
		$T_j = 150\text{ °C}$		8.5	mA	
	$V_{DRM}/V_{RRM} = 400\text{ V}$ (at mains peak voltage)			$T_j = 150\text{ °C}$		5.5

1. for both polarities of A2 referenced to A1.

Table 5. Thermal resistance

Symbol	Parameter	Value	Unit
$R_{th(j-c)}$	Junction to case (AC)	0.8	$^{\circ}C/W$

Figure 1. Maximum power dissipation versus RMS on-state current (full cycle)

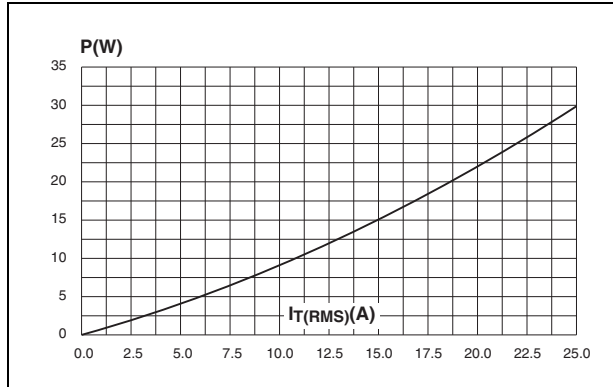


Figure 2. RMS on-state current versus case temperature (full cycle)

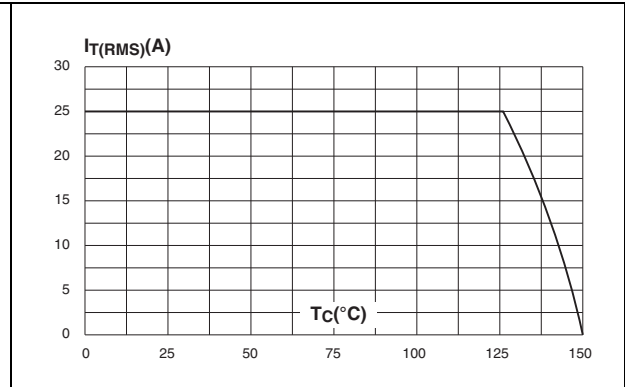


Figure 3. Relative variation of thermal impedance versus pulse duration

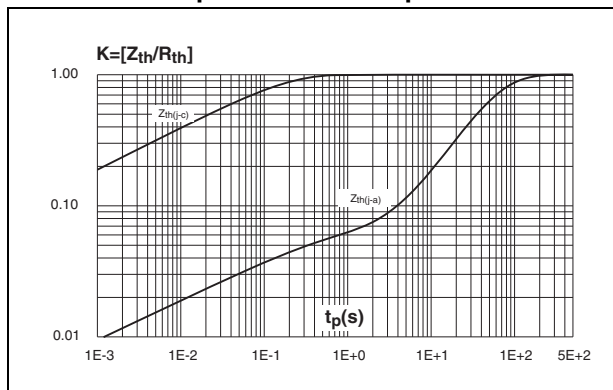


Figure 4. On-state characteristics (maximum values)

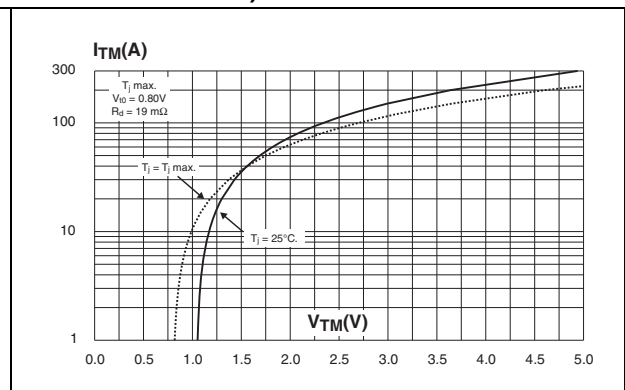


Figure 5. Surge peak on-state current versus number of cycles

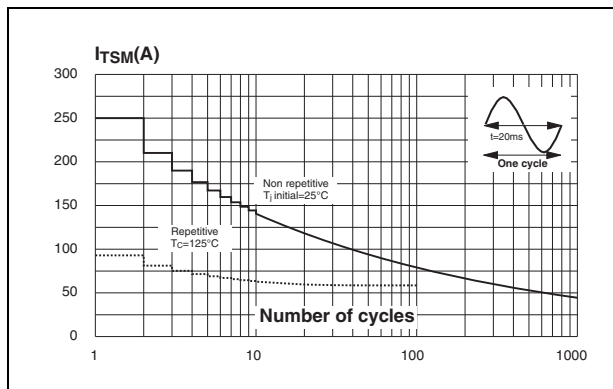
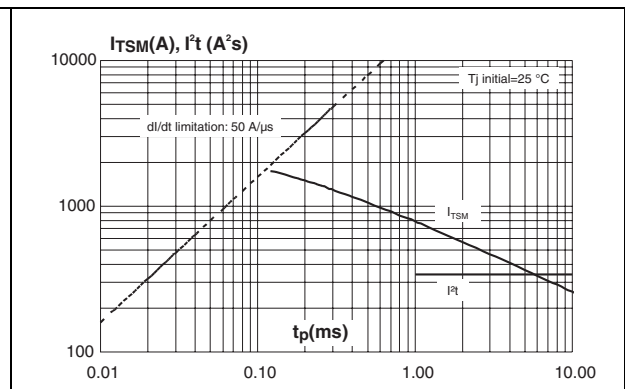
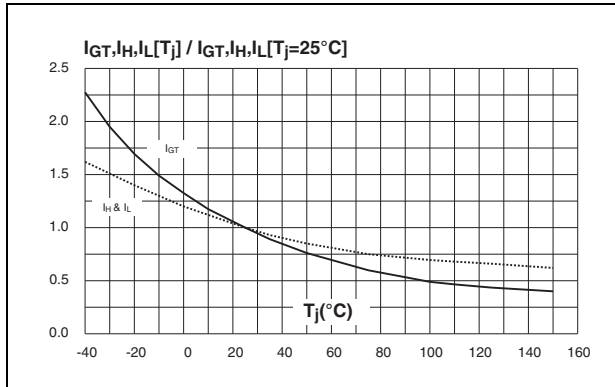


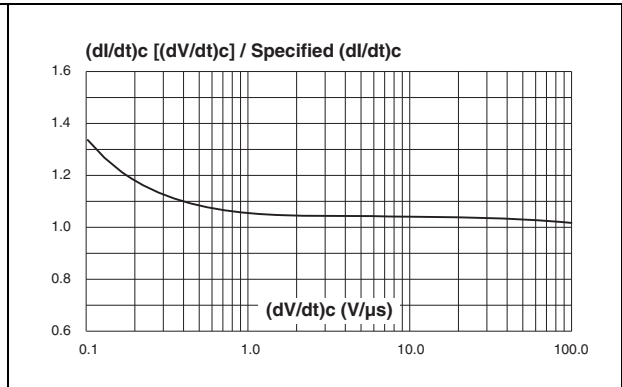
Figure 6. Non-repetitive surge peak on-state current for a sinusoidal pulse with width  $t_p < 10$  ms and corresponding value of  $I^2t$



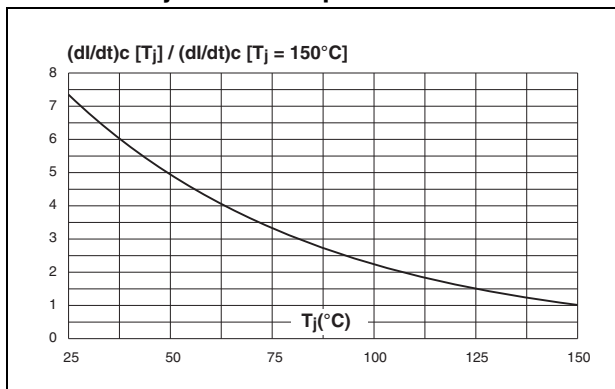
**Figure 7. Relative variation of gate trigger current, holding current and latching current versus junction temperature (typical values)**



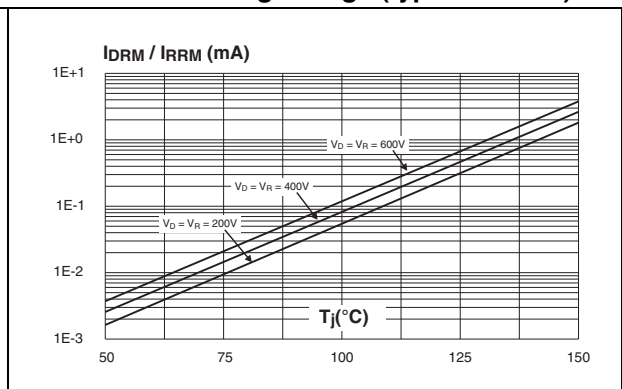
**Figure 8. Relative variation of critical rate of decrease of main current versus (dV/dt)c (typical values)**



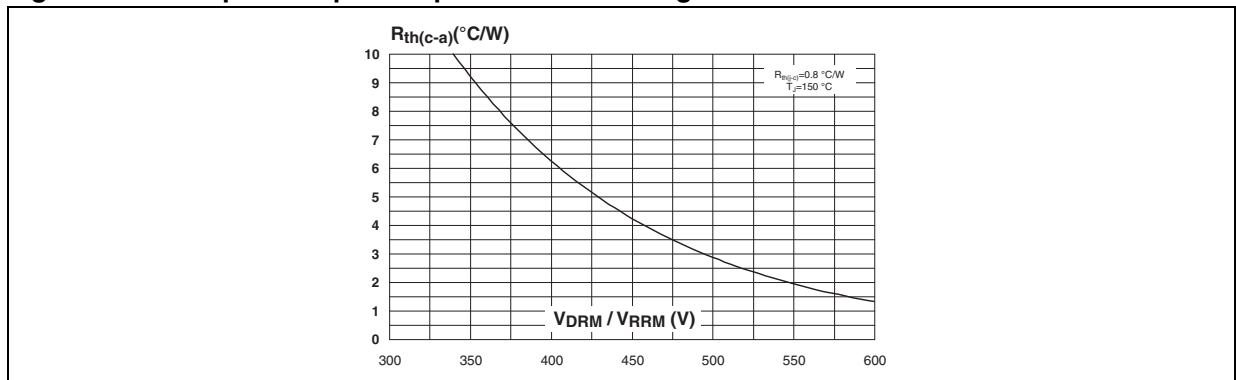
**Figure 9. Relative variation of critical rate of decrease of main current versus junction temperature**



**Figure 10. Leakage current versus junction temperature for different values of blocking voltage (typical values)**

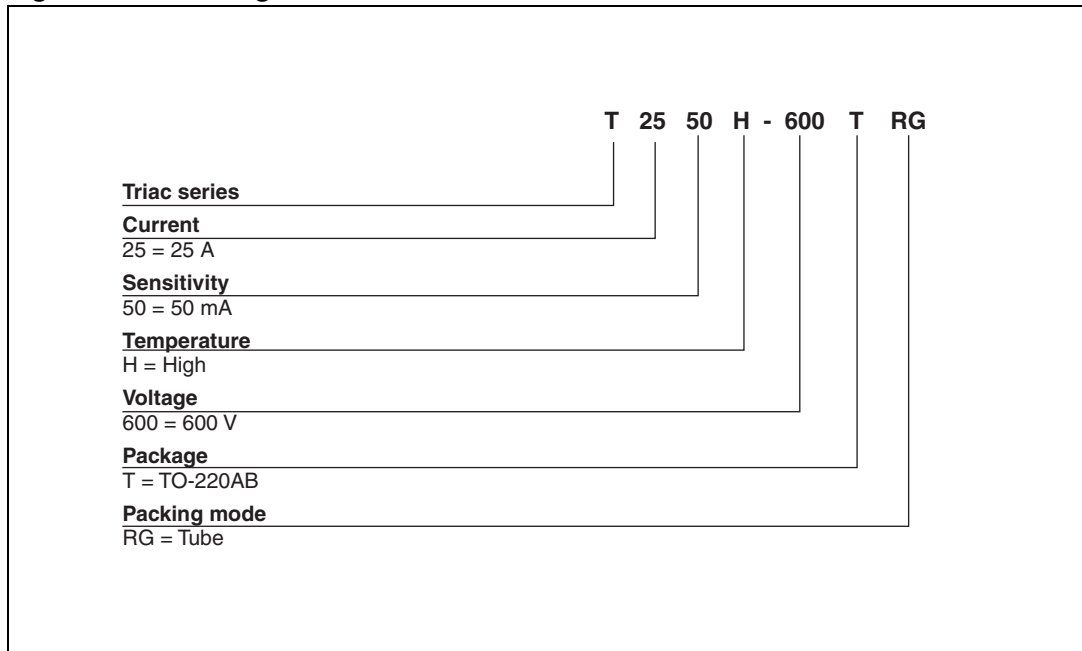


**Figure 11. Acceptable repetitive peak off-state voltage versus case-ambient thermal resistance**



## 2 Ordering information scheme

Figure 12. Ordering information scheme



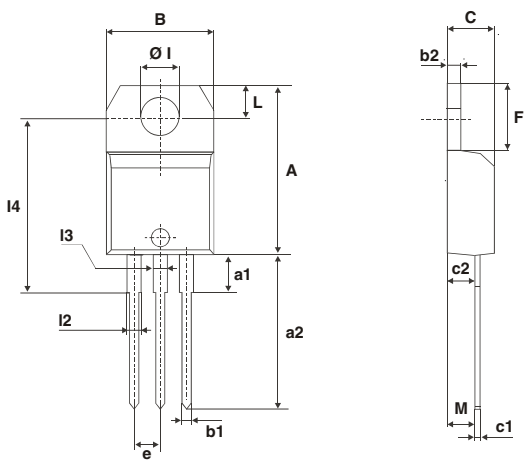
### 3 Package information

- Epoxy meets UL94, V0
- Recommended torque 0.4 to 0.6 N·m

In order to meet environmental requirements, ST offers these devices in ECOPACK<sup>®</sup> packages. These packages have a lead-free second level interconnect. The category of second level interconnect is marked on the package and on the inner box label, in compliance with JEDEC Standard JESD97. The maximum ratings related to soldering conditions are also marked on the inner box label. ECOPACK is an ST trademark. ECOPACK specifications are available at [www.st.com](http://www.st.com).

**Table 6. TO-220AB Dimensions**

Ref.	Dimensions					
	Millimeters			Inches		
	Min.	Typ.	Max.	Min.	Typ.	Max.
A	15.20		15.90	0.598		0.625
a1		3.75			0.147	
a2	13.00		14.00	0.511		0.551
B	10.00		10.40	0.393		0.409
b1	0.61		0.88	0.024		0.034
b2	1.23		1.32	0.048		0.051
C	4.40		4.60	0.173		0.181
c1	0.49		0.70	0.019		0.027
c2	2.40		2.72	0.094		0.107
e	2.40		2.70	0.094		0.106
F	6.20		6.60	0.244		0.259
ØI	3.75		3.85	0.147		0.151
I4	15.80	16.40	16.80	0.622	0.646	0.661
L	2.65		2.95	0.104		0.116
I2	1.14		1.70	0.044		0.066
I3	1.14		1.70	0.044		0.066
M		2.60			0.102	



## 4 Ordering information

Table 7. Ordering information

Order code	Marking	Package	Weight	Base qty	Delivery mode
T2550H-600TRG	T2550H600T	TO-220AB	2.3 g	50	Tube

## 5 Revision history

Table 8. Document revision history

Date	Revision	Changes
Apr-2002	5A	Last update.
13-Feb-2006	6	TO-220AB delivery mode changed from bulk to tube. ECOPACK statement added.
20-Jun-2006	7	Reformatted to current standards. Figures 6 and 11 replaced.
27-May-2008	8	Reformatted to current standards. ECOPACK statement updated.

**Please Read Carefully:**

Information in this document is provided solely in connection with ST products. STMicroelectronics NV and its subsidiaries ("ST") reserve the right to make changes, corrections, modifications or improvements, to this document, and the products and services described herein at any time, without notice.

All ST products are sold pursuant to ST's terms and conditions of sale.

Purchasers are solely responsible for the choice, selection and use of the ST products and services described herein, and ST assumes no liability whatsoever relating to the choice, selection or use of the ST products and services described herein.

No license, express or implied, by estoppel or otherwise, to any intellectual property rights is granted under this document. If any part of this document refers to any third party products or services it shall not be deemed a license grant by ST for the use of such third party products or services, or any intellectual property contained therein or considered as a warranty covering the use in any manner whatsoever of such third party products or services or any intellectual property contained therein.

**UNLESS OTHERWISE SET FORTH IN ST'S TERMS AND CONDITIONS OF SALE ST DISCLAIMS ANY EXPRESS OR IMPLIED WARRANTY WITH RESPECT TO THE USE AND/OR SALE OF ST PRODUCTS INCLUDING WITHOUT LIMITATION IMPLIED WARRANTIES OF MERCHANTABILITY, FITNESS FOR A PARTICULAR PURPOSE (AND THEIR EQUIVALENTS UNDER THE LAWS OF ANY JURISDICTION), OR INFRINGEMENT OF ANY PATENT, COPYRIGHT OR OTHER INTELLECTUAL PROPERTY RIGHT.**

**UNLESS EXPRESSLY APPROVED IN WRITING BY AN AUTHORIZED REPRESENTATIVE OF ST, ST PRODUCTS ARE NOT DESIGNED, AUTHORIZED OR WARRANTED FOR USE IN MILITARY, AIR CRAFT, SPACE, LIFE SAVING, OR LIFE SUSTAINING APPLICATIONS, NOR IN PRODUCTS OR SYSTEMS, WHERE FAILURE OR MALFUNCTION MAY RESULT IN PERSONAL INJURY, DEATH, OR SEVERE PROPERTY OR ENVIRONMENTAL DAMAGE.**

Resale of ST products with provisions different from the statements and/or technical features set forth in this document shall immediately void any warranty granted by ST for the ST product or service described herein and shall not create or extend in any manner whatsoever, any liability of ST.

ST and the ST logo are trademarks or registered trademarks of ST in various countries.

Information in this document supersedes and replaces all information previously supplied.

The ST logo is a registered trademark of STMicroelectronics. All other names are the property of their respective owners.

© 2008 STMicroelectronics - All rights reserved

STMicroelectronics group of companies

Australia - Belgium - Brazil - Canada - China - Czech Republic - Finland - France - Germany - Hong Kong - India - Israel - Italy - Japan - Malaysia - Malta - Morocco - Singapore - Spain - Sweden - Switzerland - United Kingdom - United States of America

[www.st.com](http://www.st.com)